

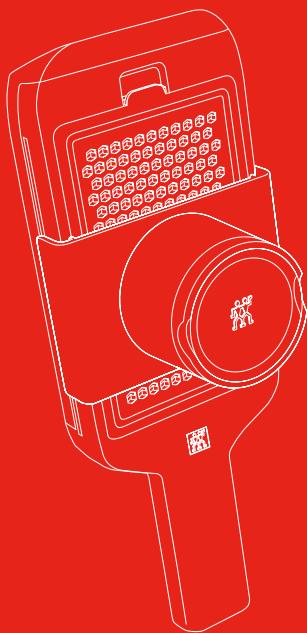

ZWILLING



Gebrauchs- und Pflegehinweise | Instructions for use and care |
Conseils d'utilisation et d'entretien | Indicaciones de uso
y cuidado | Istruzioni per l'uso e la pulitura de | Instruções de
uso e cuidado | Gebruiksaanwijzing en verzorgingsinstructies |
Инструкция по применению | ご使用とお手入れにつ
いて | 使用保养须知

ZWILLING® Z-CUT



- DE** ACHTUNG: Klingen sind sehr scharf – Verletzungsgefahr!
Verwenden Sie immer den Resteaufsatz um Verletzungen zu vermeiden.
Außer Reichweite von Kindern aufbewahren.
- EN** ATTENTION: Blades are very sharp – risk of injury!
Always use the removable food press to avoid injuries.
Keep out of the reach of children.
- FR** ATTENTION : les lames sont très acérées – risques de blessures !
Utilisez toujours le tube d'appui pour éviter les blessures.
À conserver hors de portée des enfants.
- ES** ¡PRECAUCIÓN: las cuchillas están muy afiladas y existe peligro de lesiones!
Utilice siempre el soporte de restos para evitar lesiones.
Manténgase fuera del alcance de los niños.
- IT** ATTENZIONE: le lame sono molto affilate – pericolo di lesioni!
Utilizzare sempre il pressino rimovibile per evitare lesioni.
Tenere lontano dalla portata dei bambini.
- PT** ATENÇÃO: Lâminas muito afiadas – perigo de ferimentos!
Sempre utilize o acessório de proteção de dedos para evitar ferimentos.
Manter fora do alcance das crianças.
- NL** LET OP: de messen zijn zeer scherp – gevaar voor verwondingen!
Plaats altijd de beschermkap wanneer u het product opbergt.
Buiten bereik van kinderen bewaren.
- RU** ВНИМАНИЕ: Очень острые лезвия – опасность травмирования!
Во избежание травм необходимо использовать защитную насадку.
Хранить в недоступном для детей месте.
- JP** 注意：刃は非常に鋭くなっています – ケガを追う危険！
ケガを防ぐために、必ず取り外し式フードプレスを使用してください。
子供の手の届かない場所に保管してください。



CN 注意：刀刃非常锋利 - 有受伤危险！
请始终使用零碎食物护套，以免受伤。
保存在儿童接触不到的地方。

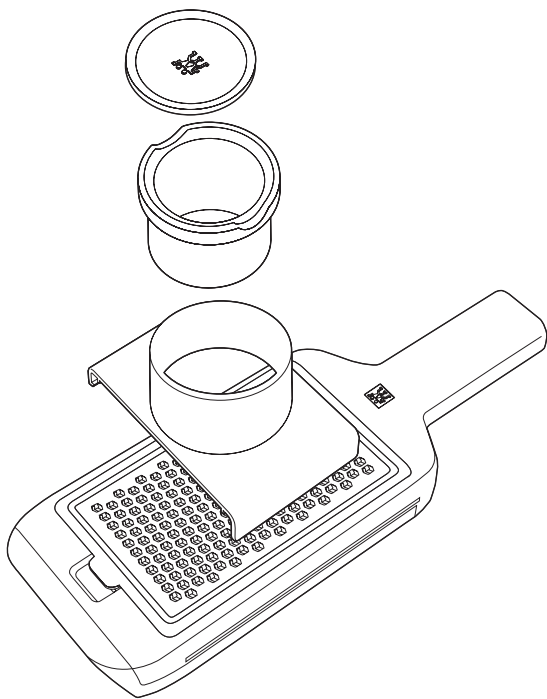

1.

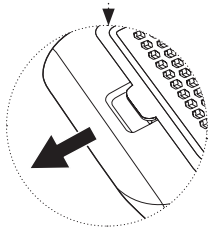
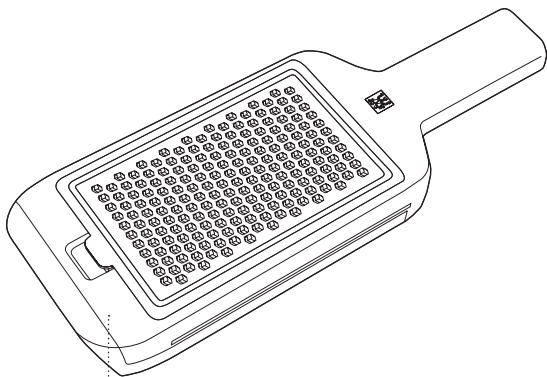

2.

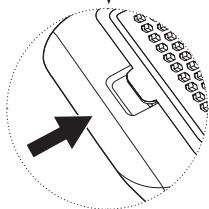
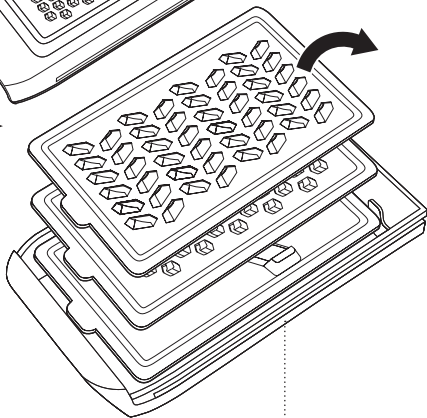
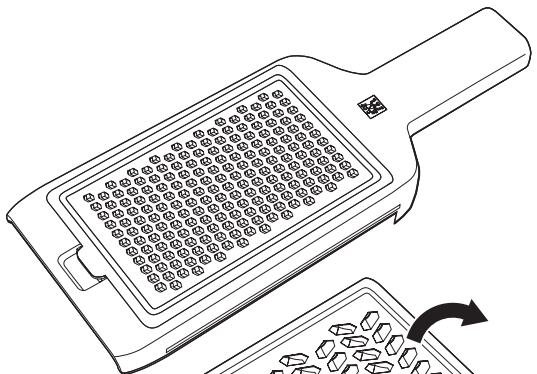

3 a.

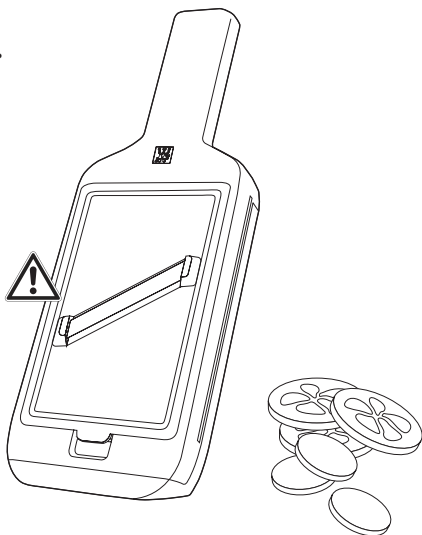

c.

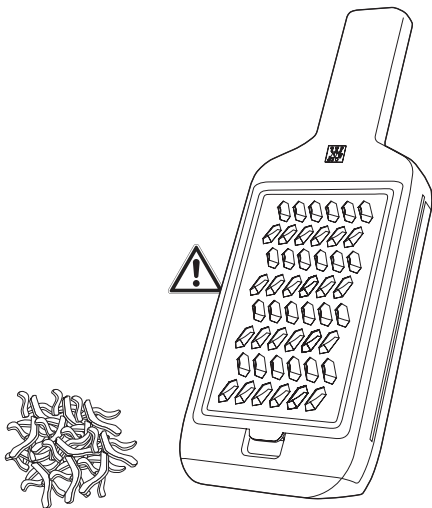

b.

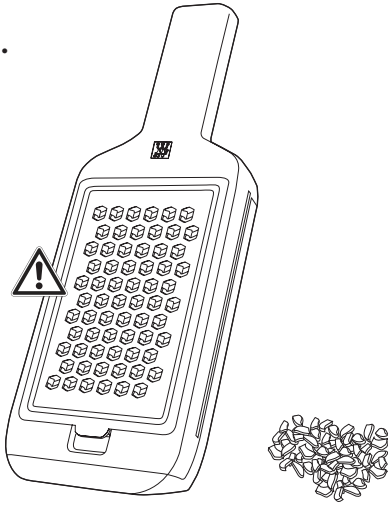

d.

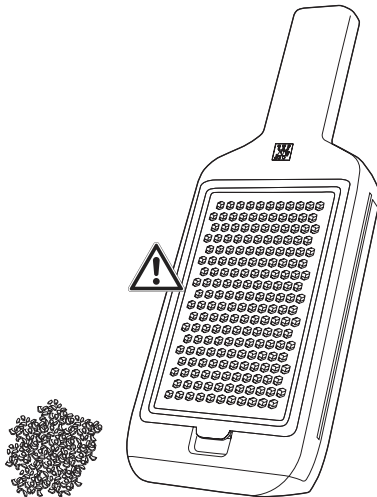

4.

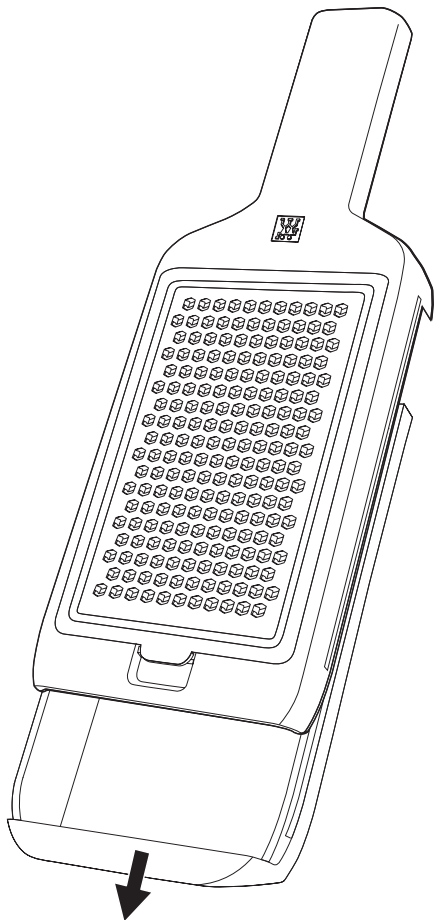

5.

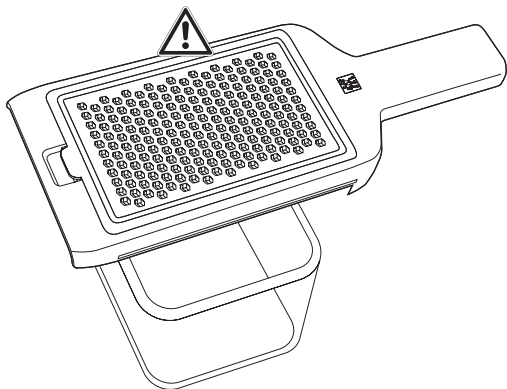
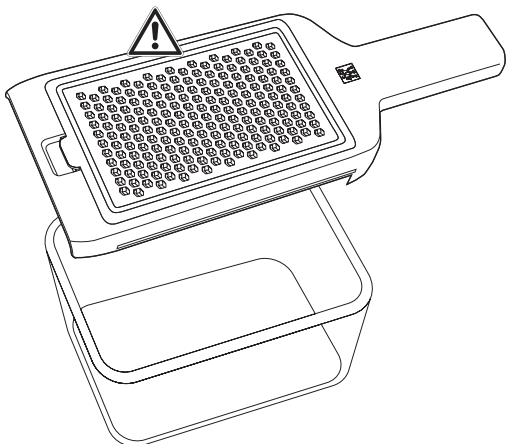

6.

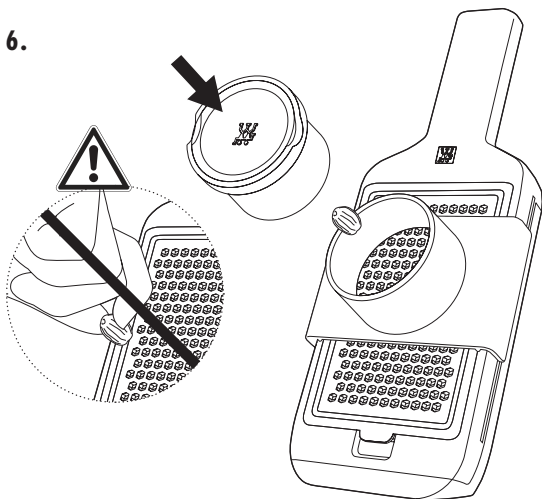

7.

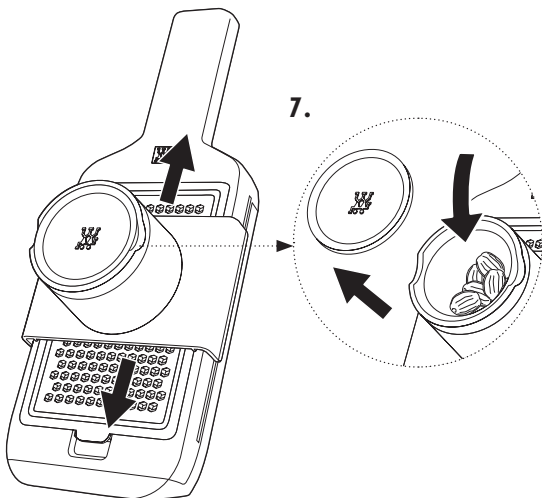

8.



- DE** Spülmaschinengeeignet. Reinigung von Hand empfohlen.
- EN** Dishwasher safe. Hand washing is recommended.
- FR** Lavable au lave-vaisselle. Le lavage manuel est recommandé.
- ES** Apto para lavavajillas. Se recomienda lavar a mano.
- IT** Adatto al lavaggio in lavastoviglie. Si consiglia di lavarlo a mano.
- PT** Próprio para máquina de lavar loiça. Recomenda-se a limpeza à mão.
- NL** Vaatwasmachinebestendig. Met de hand afwassen aanbevolen.
- RU** Подходит для обработки в посудомоечной машине
Рекомендуется очистка вручную.
- JP** 食器洗浄機対応。手洗いすることをお勧めします。
- CN** 适于用洗碗机清洗。建议手洗。





www.zwilling.com

8001526Y1 · 06/2021 · © 2021 ZWILLING J.A. Henckels AG